

D50-TURBO-G2ZW

5 MP Vandal-proof Motorized
Varifocal Dome Camera

epcom[®]

Professional Video Surveillance Solutions



- High quality imaging with 5 MP, 2560 × 1944 resolution
- 2.7 mm to 13.5 mm motorized varifocal lens
- Up to 40 m IR distance for bright night imaging
- One port for four switchable signals (TVI/AHD/CVI/CVBS)
- Water and dust resistant (IP67) and vandal resistant (IK10)



epcom[®]

Professional Video Surveillance Solutions

▪ Specification





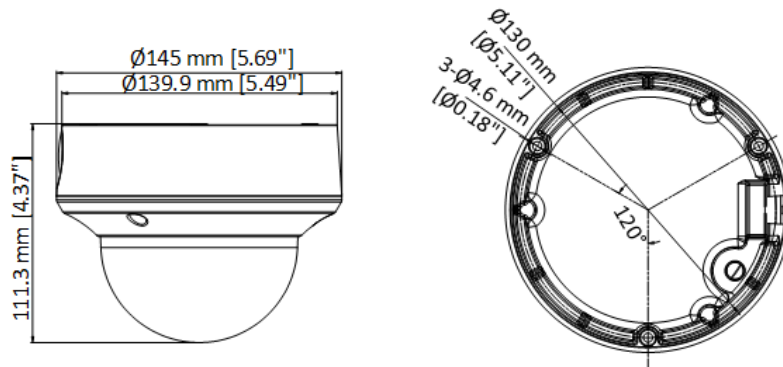



Camera	
Image Sensor	5 MP CMOS
Signal System	PAL/NTSC
Resolution	2560 (H) × 1944 (V)
Frame Rate	TVI: 5 M @ 20 fps, 4 M @ 30 fps, 4 M @ 25 fps, 1080p @ 30 fps, 1080p @ 25 fps AHD: 5 M @ 20 fps, 4 M @ 30 fps, 4 M @ 25 fps CVI: 4 M @ 30 fps, 4 M @ 25 fps CVBS: PAL/NTSC
Min. Illumination	0.01 Lux @ (F1.2, AGC ON), 0 Lux with IR
Shutter Time	PAL: 1/25 s to 1/50,000 s; NTSC: 1/30 s to 1/50,000 s
Lens	2.7 mm to 13.5 mm motorized varifocal lens
Field of View	horizontal FOV: 95° to 26°, vertical FOV: 72° to 20°, diagonal FOV: 126° to 33°
Lens Mount	Φ14
Day & Night	IR Cut Filter
WDR (Wide Dynamic Range)	Digital WDR
Angle Adjustment	Pan: 0° to 355°, Tilt: 0° to 75°, Rotation: 0° to 355°
Image	
Day/Night Mode	Auto/Color/BW (Black and White)
Image Mode	STD/HIGH-SAT
AGC	Yes
White Balance	Auto/Manual
AE (Auto Exposure) Mode	DWDR, BLC, HLC, Global
Noise Reduction	2D DNR
Language	English
Function	Brightness, Smart IR, Sharpness
Interface	
Video Output	Switchable TVI/AHD/CVI/CVBS
General	
IR Range	Up to 40 m
Operating Conditions	-40°C to 60°C (-40°F to 140°F), Humidity: 90% or less (non-condensing)
Power Supply	12 VDC±15%, 24 VAC±15%
Consumption	Max 5.9 W
Protection Level	IP67, IK10
Material	Metal
Communication	HIKVISION-C
Dimension	Ø145 mm × 111.3 mm (5.69" × 4.37")
Weight	Approx. 837 g (1.85 lb.)

▪ Dimension

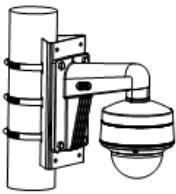
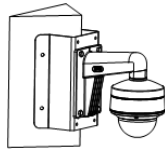
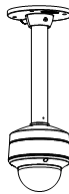

▪ Accessory

▪ Optional

DS-1281ZJ-DM45	DS-1275ZJ-SUS	DS-1276ZJ-SUS	DS-1271ZJ-140-DM45	DS-1273ZJ-140-DM45
Junction box	Vertical pole mount	Corner mount	Vertical mount	Wall mount
				
				
DS-1280ZJ-DM45				
Junction box				
